

# SIZE 2 (24000) END FITTING CENTRE LINE DRAWING

## TOP VIEW

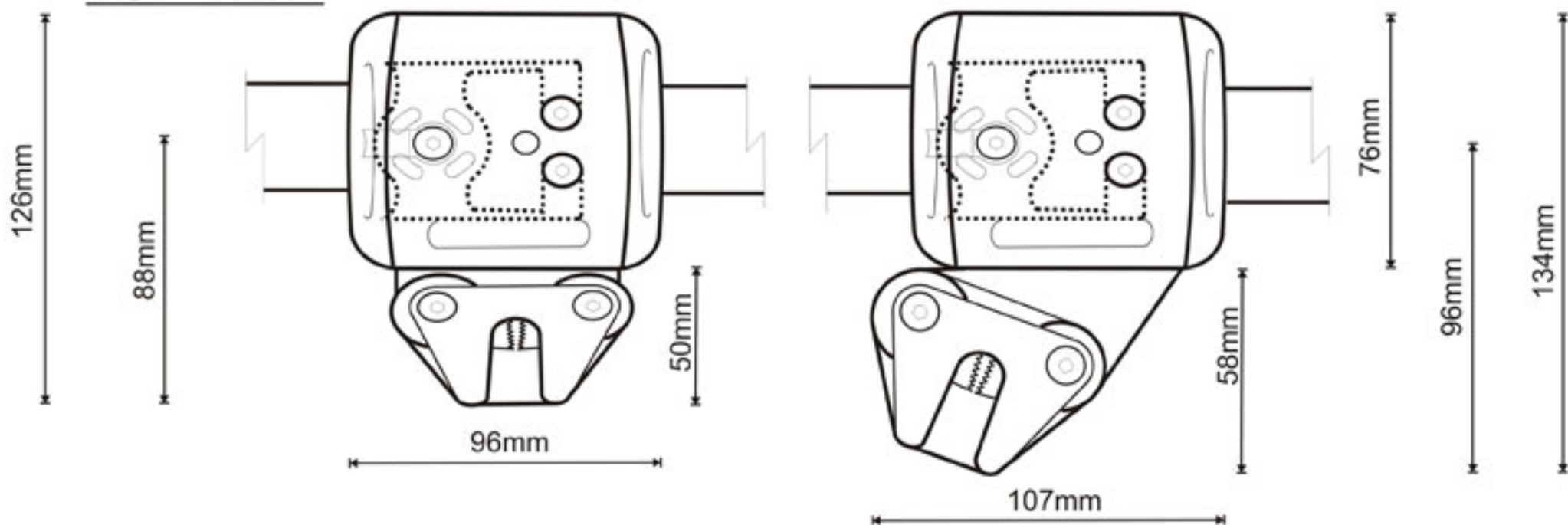

## END VIEW

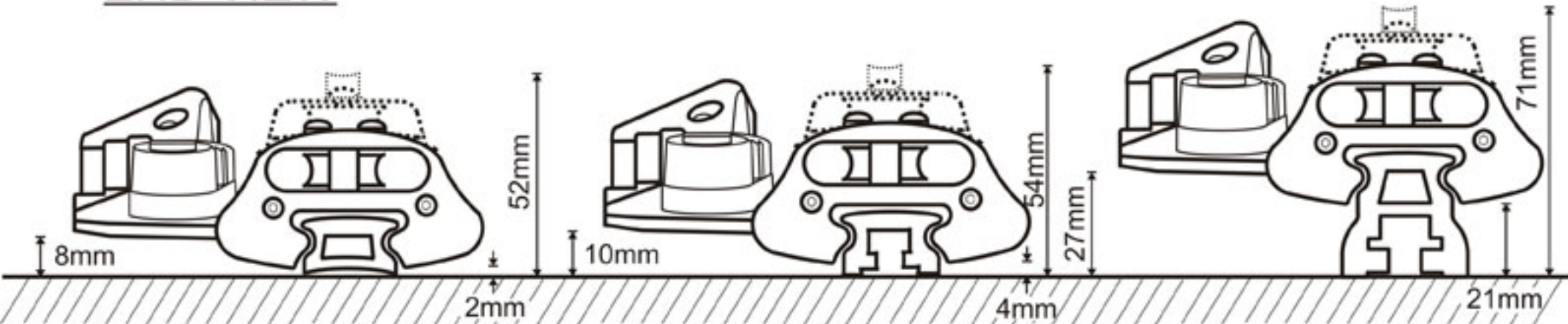

DRILLED

SLIDING BOLT

BEAM